

CARTONING MACHINERY

# 15DZ

## Hand Load Cartoner

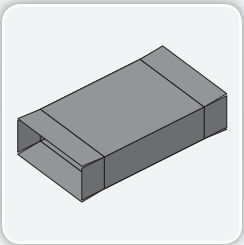

where products meet packaging®

Featuring a smooth and efficient double-head rotary carton feed system with optional orbital feed and pre-break, the 15DZ delivers class-leading carton erecting performance in a compact and economical package. Capable of erecting and sealing a wide range of carton sizes at speeds up to 60 cycles per minute, the affordable 15DZ is ideal for the most demanding and cost conscious production environments. Fast changeover, simple operation and ergonomic design, along with the ability to easily and economically add a barrel cam auto-load system, really set this machine apart from the crowd. Plus, for challenging applications, you'll love the special flap tucker design of the 15DZ. Like all ADCO machines, the 15DZ is constructed in stainless steel and is available in standard or wash-down configurations.

### Benefits

- Stainless steel construction provides maximum strength as well as improved sanitation over traditional designs
- Fast, easy changeover with scales and pointers and available digital counters maximizes reliability and increases productivity
- Intuitive and modern interface enhances operator experience and improves overall equipment effectiveness (OEE)
- Advanced guard design keeps operators safe and maximizes maintenance access

# 15DZ - Hand Load Cartoner

## Product Features

- Stainless steel construction, welded frame
- Compact frame with leveling feet and casters
- Double-head rotary carton feeder with optional Orbital Feeder and Pre-break
- Ergonomically-designed product load table
- Capable of closing either tablock style or glued cartons
- Nordson® ProBlue hot melt glue system (when glue is specified)
- Allen-Bradley® control package
- Category 3 safety system with a fully interlocked barrier guard package
- Many options available upon request

## Typical Applications

- Flow-wrapped products
- Frozen foods
- Bag-in-box
- Baked goods
- Snack foods
- Dairy products

## Utilities

### Electrical

230/460 VAC, 3-Phase with ground (PE), 60 Hz

### Air Consumption

10 CFM @ 95 PSI

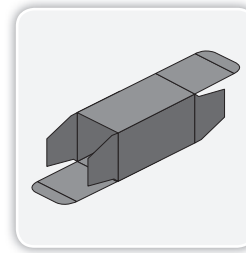
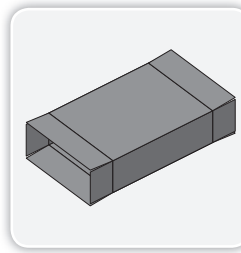
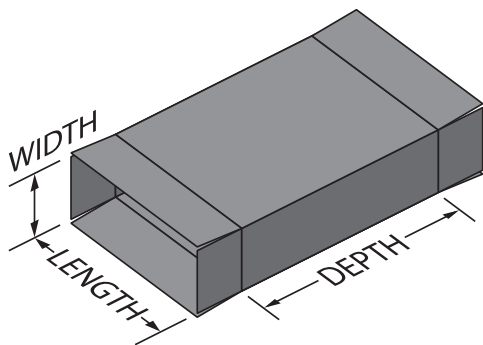

## PLAN VIEW

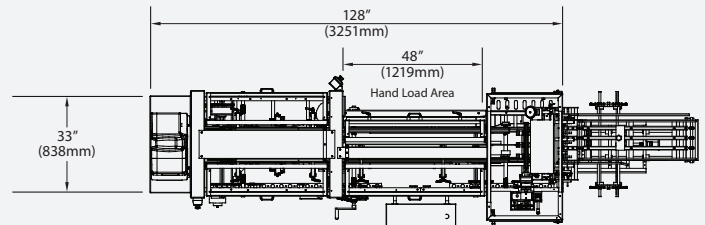

## SIDE ELEVATION

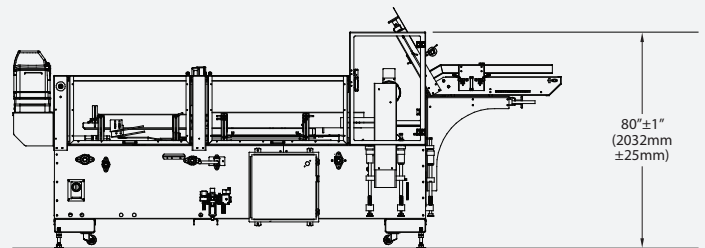

## CARTON SIZE RANGE

Dimensions	(in)		(mm)	
	Min	Max	Min	Max
Length of Opening	1	9	25	230
Width of Opening	1	4	25	100
Case Depth	4	12	100	305

Not all minimums and maximums apply.  
Special modifications are available to extend the size range.

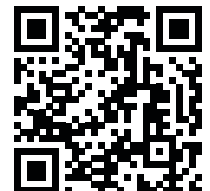

For more information about this machine, scan the QR code above with your mobile device