

CARTONING MACHINERY

15D105

Hand Load Cartoner



DARTRONICS, INC.
PACKAGING AUTOMATION SPECIALISTS

ADCO 
where products meet packaging



* Optional infeed conveyor shown

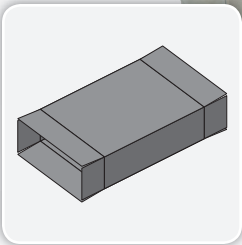

where products meet packaging[®]

There is a reason the 15D105 is one of the most recognized cartoners among packagers. Capable of forming a wide range of carton sizes and styles at speeds up to 125 cartons per minute, the affordable 15D105 is ideal for the most demanding and cost conscious production environments. The 15D105 features continuous motion design, delivering smooth, efficient and reliable operation all day, every day. Designed for easy conversion to a fully automatic barrel cam machine, you can rest assured that as your production needs change the 15D105 can change with you. Fast changeover, simple operation and excellent ergonomics, all hallmarks of the 15D105, make this machine an incredibly popular choice. Like all ADCO machines, the 15D105 is constructed in stainless steel and is available in standard or wash-down configurations.

Benefits

- Stainless steel construction improves cleanability and eliminates corrosion
- 2-head rotary carton feeder ensures smooth, efficient operation
- Fast, easy changeover with screw adjustable overheads maximizes productivity
- Compact frame with leveling feet and casters saves space and maximizes portability
- Large carton size range with oversizing options protects your investment as products change
- Ergonomically designed product load table minimizes fatigue and maximizes productivity
- Advanced guard design keeps operators safe and maximizes maintenance access

15D105 - Hand Load Cartoner

Product Features

- Stainless steel construction
- Compact frame with leveling feet and casters
- High capacity, easy to load carton magazine
- 2-head rotary carton feeder
- Ergonomically designed 6" dual station product load table
- Capable of erecting and sealing either tablock style or glued cartons
- Nordson® ProBlue hot melt glue system (when glue is specified)
- Allen-Bradley® control package
- Fully interlocked barrier guard package
- USDA listed
- Many options available upon request

Typical Applications

- Bag-in-box
- Flow wrapped bars
- Frozen food
- Ready meals
- Pharmaceutical
- Dairy products

Utilities

Electrical

230/460 VAC, 3-Phase with ground (PE), 60 Hz

Air Consumption

10 CFM @ 95 PSI

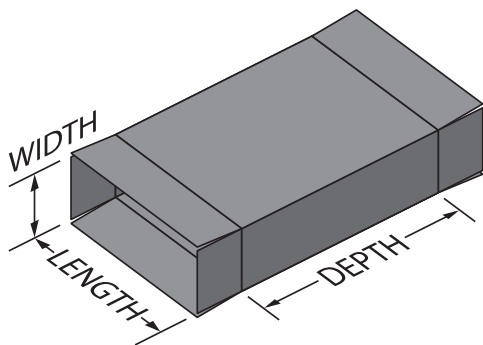
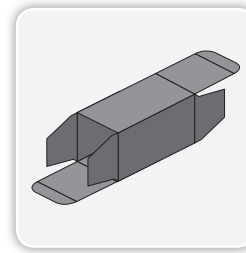
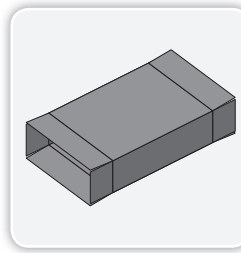

PLAN VIEW

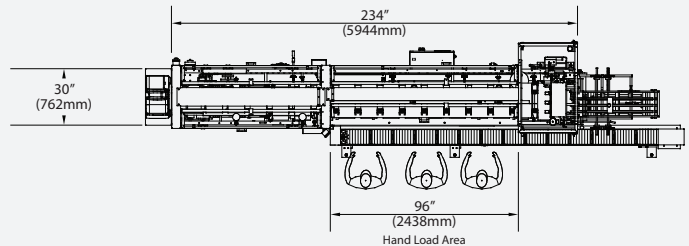

SIDE ELEVATION

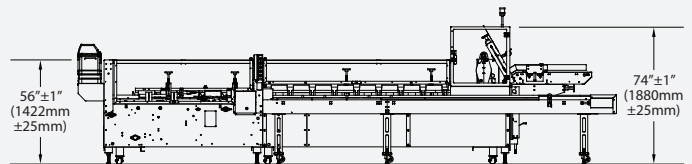

CARTON SIZE RANGE

Dimensions	(in)		(mm)	
	Min	Max	Min	Max
Length of Opening	1	9	25	229
Width of Opening	.75	4	20	100
Case Depth	4	12	100	305

Not all minimums and maximums apply.
Special modifications are available to extend the size range.

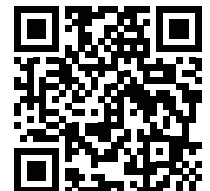

For more information about this machine, scan the QR code above with your mobile device